

Status of DELTA: Light Source and Short-Pulse Facility

1

Shaukat Khan, Center for Synchrotron Radiation, TU Dortmund



ESLS, Grenoble November 25th 2014

Parameters and availability

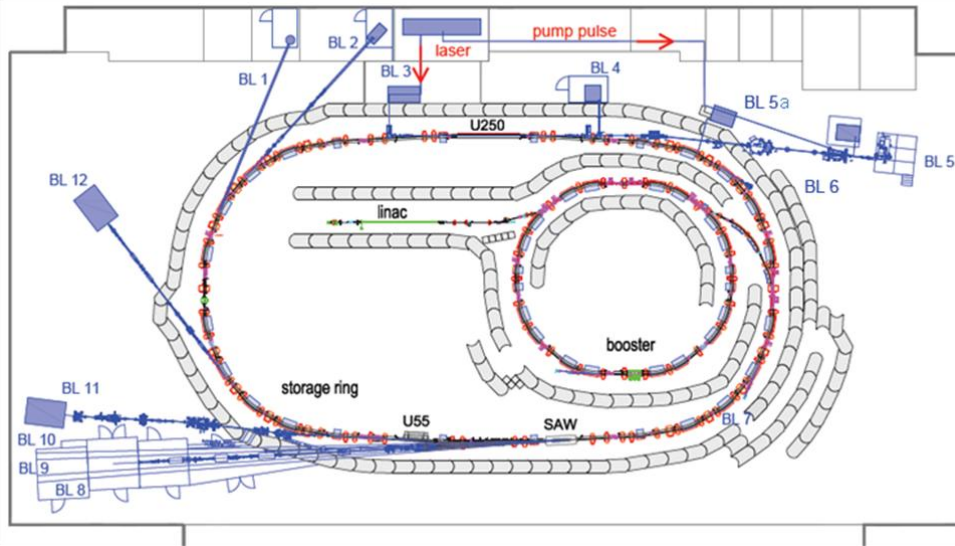

Parameters

circumference	115.2 m
beam energy	1.5 GeV
beam current	130 mA multi-bunch
beam current	20 mA single bunch
beam lifetime	~14 h at 100 mA
hor. emittance	~15 nm rad
bunch length	40 ps rms
user operation	2000 h/y (20 weeks/y)
machine studies	1000 h/y (10 weeks/y)

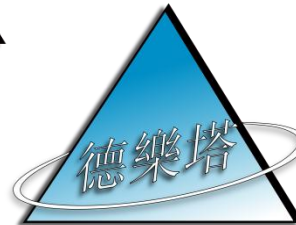
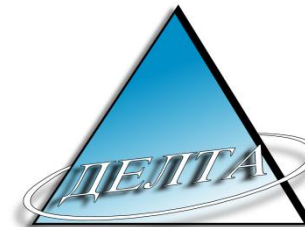

Parameters and availability

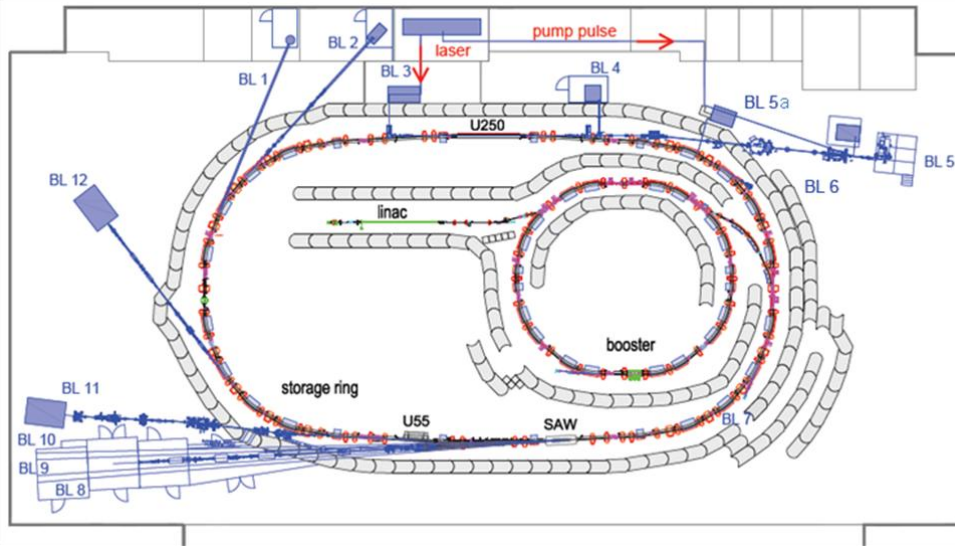

Parameters

circumference	115.2 m
beam energy	1.5 GeV
beam current	130 mA multi-bunch
beam current	20 mA single bunch
beam lifetime	~14 h at 100 mA
hor. emittance	~15 nm rad
bunch length	40 ps rms
user operation	2000 h/y (20 weeks/y)
machine studies	1000 h/y (10 weeks/y)

I. 2012	II. 2012	III. 2012	IV. 2012	I. 2013	II. 2013	III. 2013	IV. 2013	I. 2014	II. 2013	III. 2013
94,7%	90,8%	85,0%	99,0%	96,6%	97,0%	89,0%	96,4%	70,2%	98,0%	68,3%

III. 2013

- unexplained orbit motion
- large voltage fluctuations (defective "powerformer")
- short-circuit fault causing damage



Parameters and availability

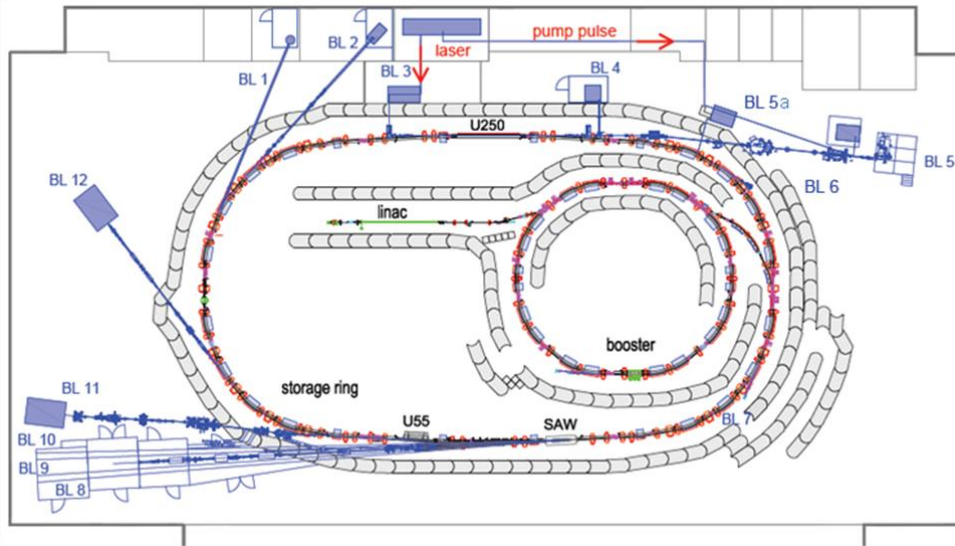

Parameters

circumference	115.2 m
beam energy	1.5 GeV
beam current	130 mA multi-bunch
beam current	20 mA single bunch
beam lifetime	~14 h at 100 mA
hor. emittance	~15 nm rad
bunch length	40 ps rms
user operation	2000 h/y (20 weeks/y)
machine studies	1000 h/y (10 weeks/y)

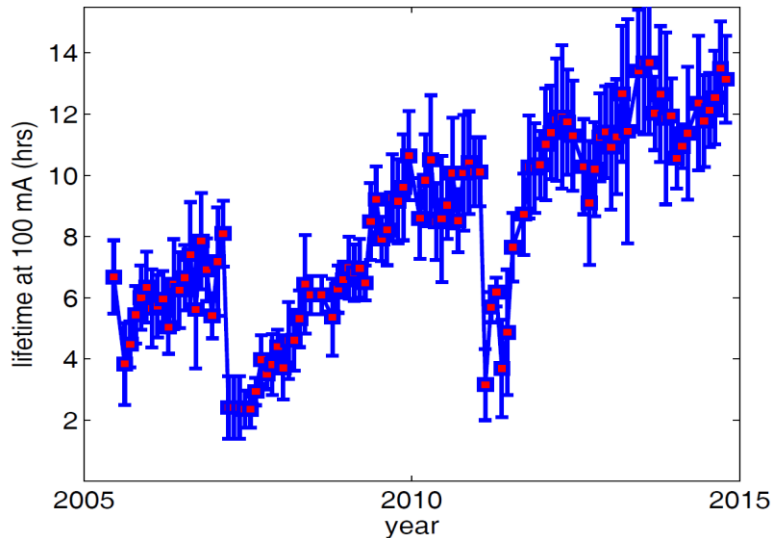

Beam lifetime at 100 mA 2005-2014

- has steadily improved
- no venting since 2012
- RF phase modulation

Alignment of the storage ring

(U. Berges, G. Dahlmann, T. Dybiona, B. Isbarn, B. Hippert, P. Kortmann, G. Pike**, H. Rast, G. Schmidt, T. Schulte-Eickhoff; **Faculty of Physics, TU Dortmund)



Vertical alignment completed in 2013

- improved stability, injection efficiency, radiation level

Horizontal alignment underway

- 180 reference panels for Taylor-Hobson spheres in place
- laser tracker with interferometric distance measurement

Superconducting wiggler

(W. Brembt, P. Hartmann, B. Hippert, S. Khan, V. Kniss, P. Kortmann, R. Molo, M. Paulus, D. Schirmer, G. Schmidt, C. Sternemann, M. Tolan)



Superconducting asymmetric wiggler

- is aging, no support from manufacturer
- **request for funding underway**
- no asymmetry option
- higher field (5.3 T \rightarrow 7 T)
- more periods (5 \rightarrow 10)
- less He consumption (130 l/week \rightarrow none)

Additional issues

- second RF cavity and solid-state RF amplifier
- modified storage ring lattice
- new vacuum chamber and absorber
- beamline modifications
- integration into control system
- radiation safety

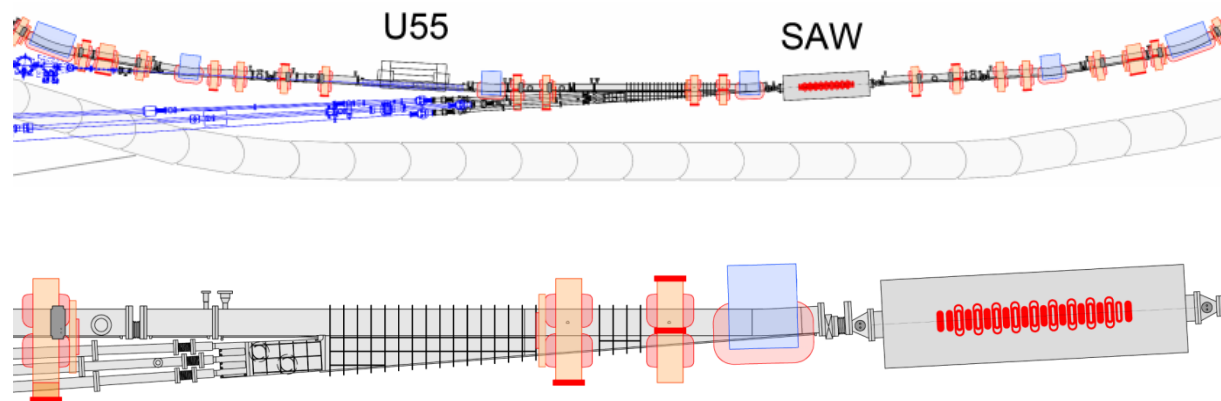

Stability

(P. Hartmann, S. Khan, B. Riemann, G. Schünemann, P. Towalski, T. Weis)

Fast orbit feedback installed and tested

- frequency range 1 - 400 Hz
- 19 horizontal and 21 vertical correctors installed
- FPGA-based controllers and communication
- **first results**

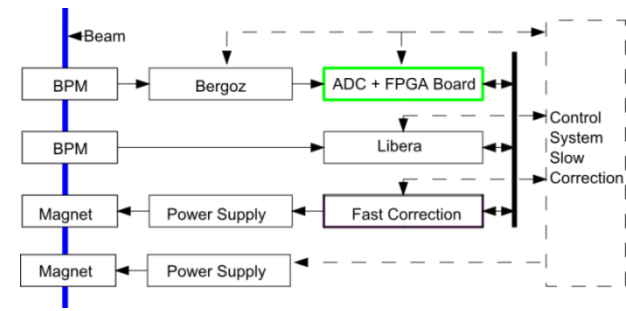
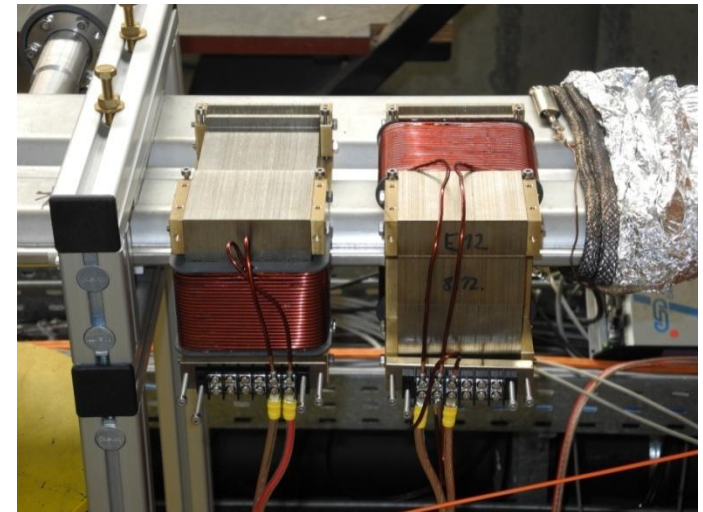
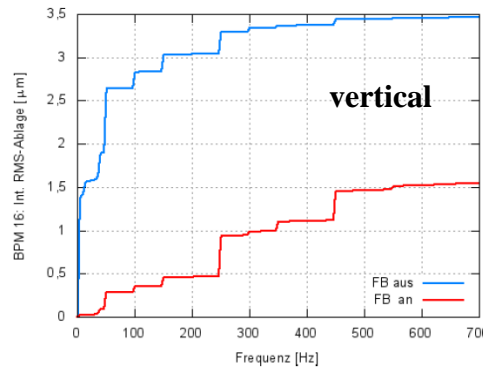
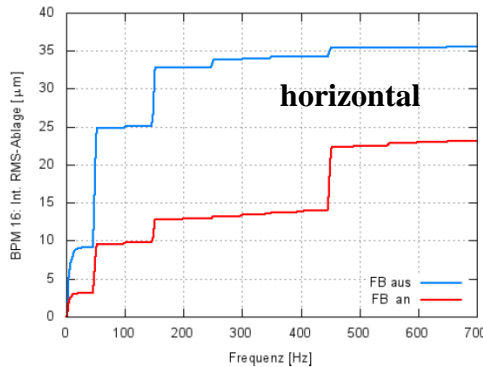
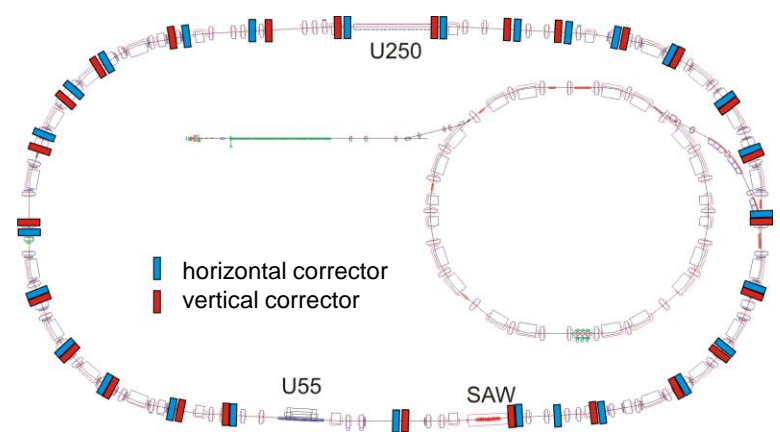

Stability

(M. Höner, S. Khan, M. Sommer, C. Waldera)



Bunch-by-bunch feedback systems (installed 2011)

- damp longitudinal and transverse oscillations,
- used for accelerator studies and diagnostics
- ... instabilities, injection studies, beam loss monitor



example: longitudinal damping rates

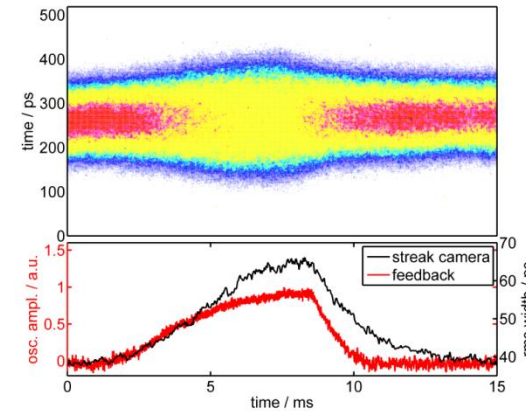
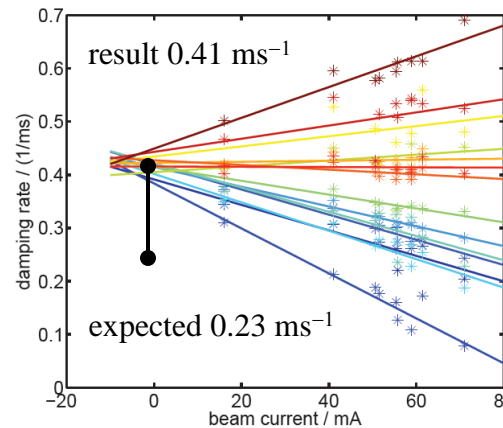
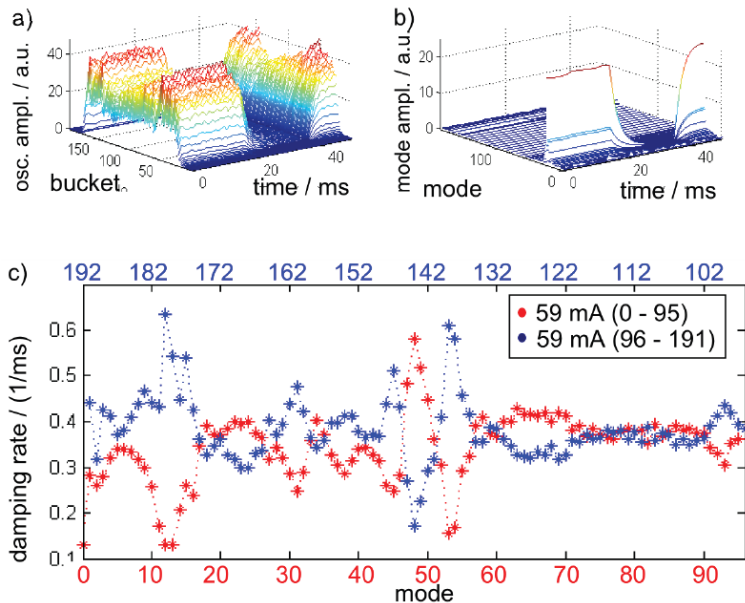

Facility for ultrashort VUV and THz pulses

(F. Bahnsen, J. Greve, M. Höner, S. Hilbrich, H. Huck, M. Huck, S. Khan, A. Meyer auf der Heide, R. Molo, H. Rast, A. Schick, P. Ungelenk [TU Dortmund],
 S. Cramm, S. Döring, L. Plucinski, C. Schneider [FZ Jülich and U Duisburg-Essen],
 N. Hiller, V. Judin, J. Raasch, M. Siegel, P. Thoma [KIT Karlsruhe],
 S. Bielawski, C. Evain, M. Le Parquier, E. Roussel, C. Szwaj [U Lille/France],
 C. Gutt, M. Reiser, T. Sant, S. Warsaw [U Siegen])

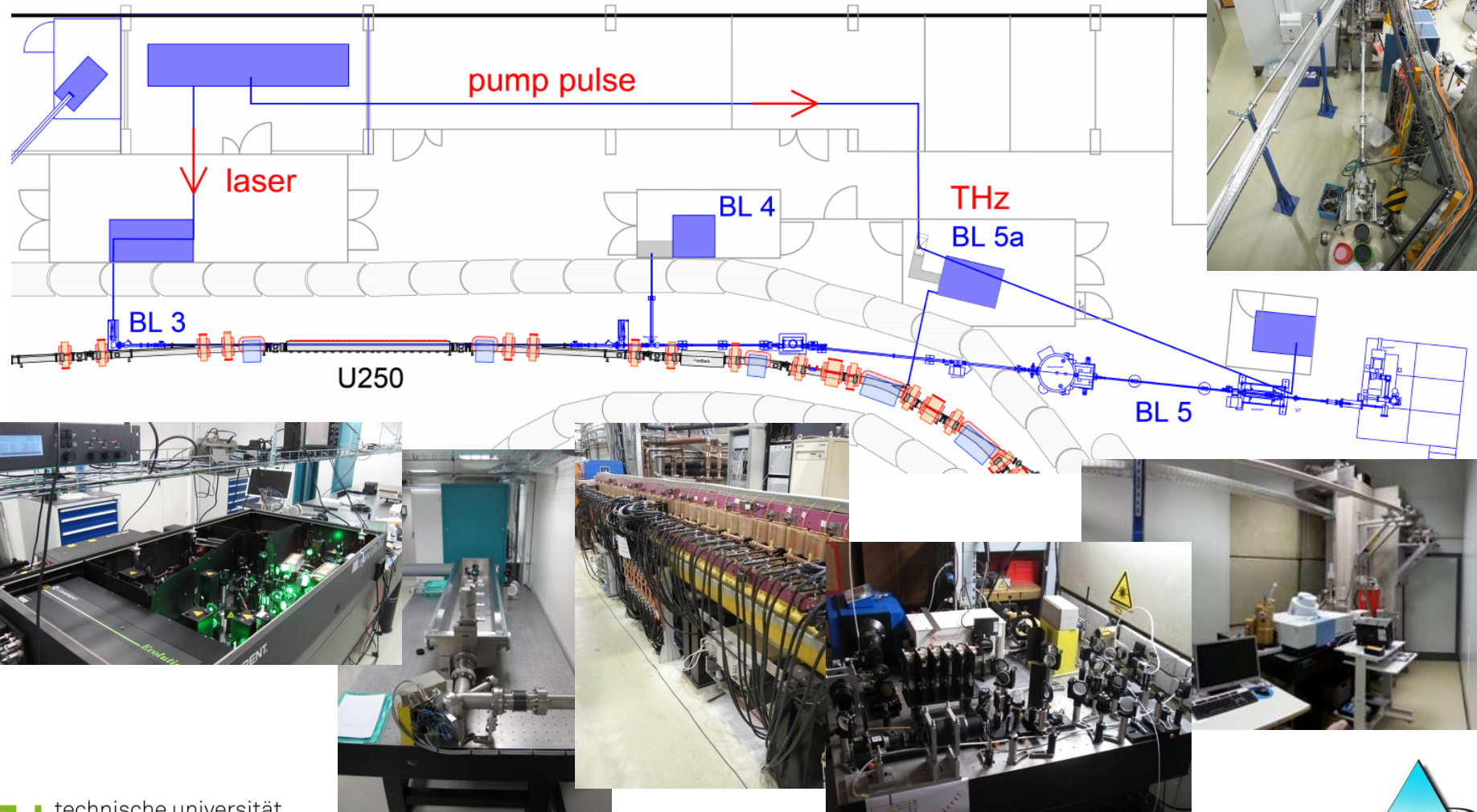

Facility for ultrashort VUV and THz pulses

Coherent harmonic generation (CHG)

- laser-induced energy modulation within a bunch "slice"
- density modulation in a magnetic chicane
- coherent radiation at harmonics of the laser wavelength (so far 80 nm, goal 53 nm)

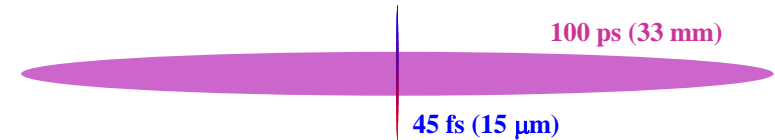

Coherent terahertz (THz) radiation

- short "dip" due to energy-dependent path length
- broadband coherent THz radiation
- narrowband coherent THz radiation from multiple dipoles

$$\lambda_L = \lambda = \frac{\lambda_U}{2\gamma^2} \left(1 + \frac{K^2}{2} + \gamma^2 \theta^2 \right)$$

electric field E

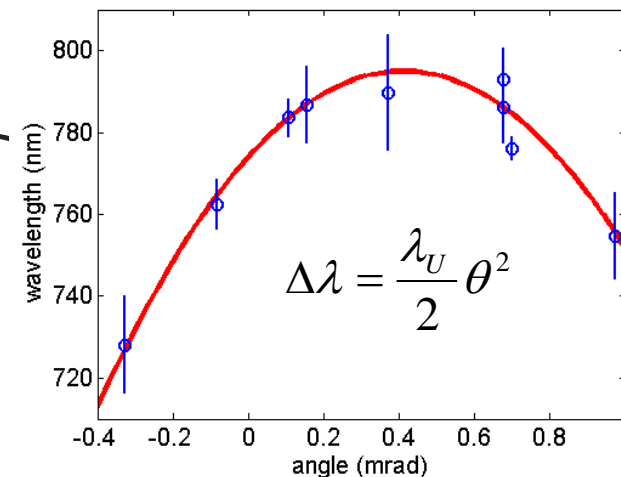
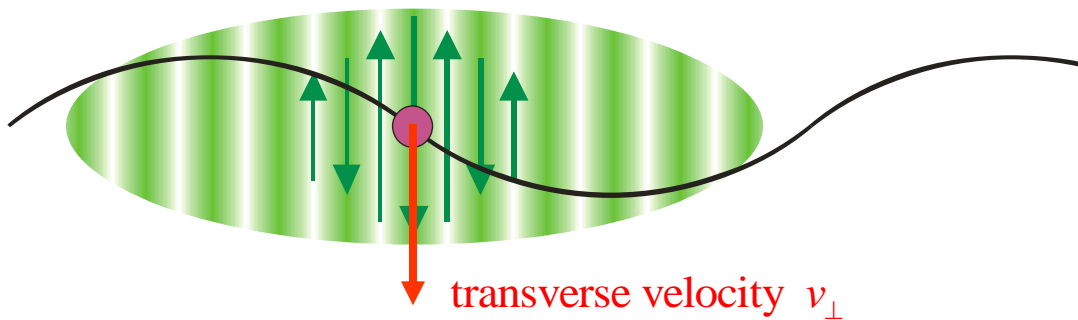

Facility for ultrashort VUV and THz pulses

Coherent harmonic generation (CHG)

- laser-induced energy modulation within a bunch "slice"
- density modulation in a magnetic chicane
- coherent radiation at harmonics of the laser wavelength (so far 80 nm, goal 53 nm)

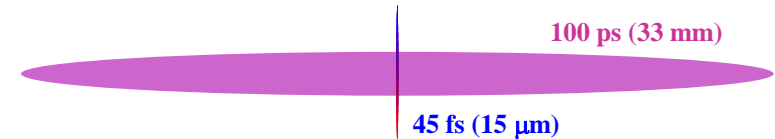

Coherent terahertz (THz) radiation

- short "dip" due to energy-dependent path length
- broadband coherent THz radiation
- narrowband coherent THz radiation from multiple dips

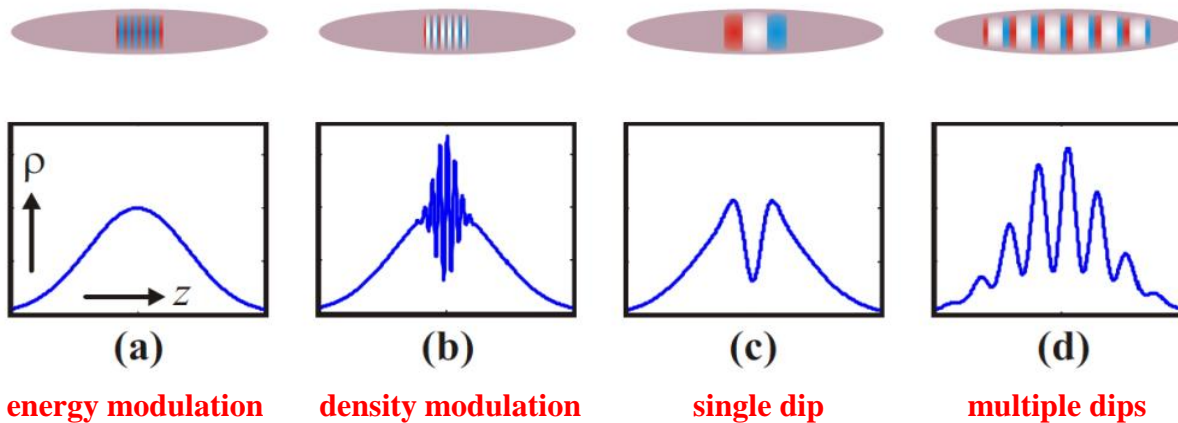

Facility for ultrashort VUV and THz pulses

Coherent harmonic generation (CHG)

- laser-induced energy modulation within a bunch "slice"
- density modulation in a magnetic chicane
- coherent radiation at harmonics of the laser wavelength (so far 80 nm, goal 53 nm)

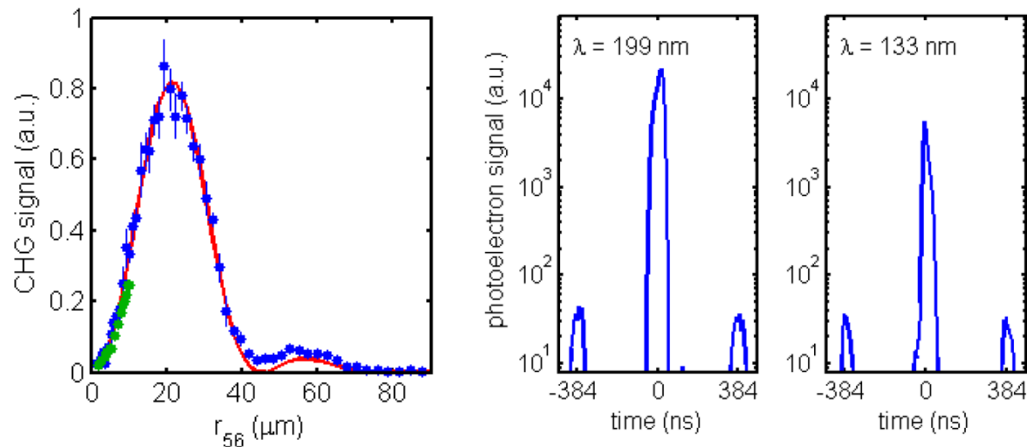
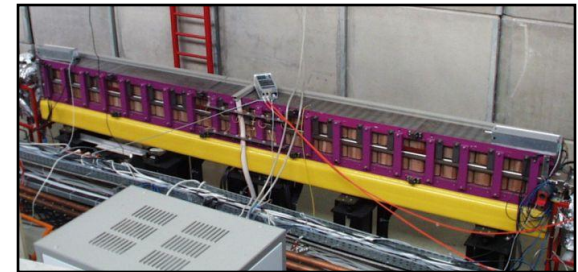
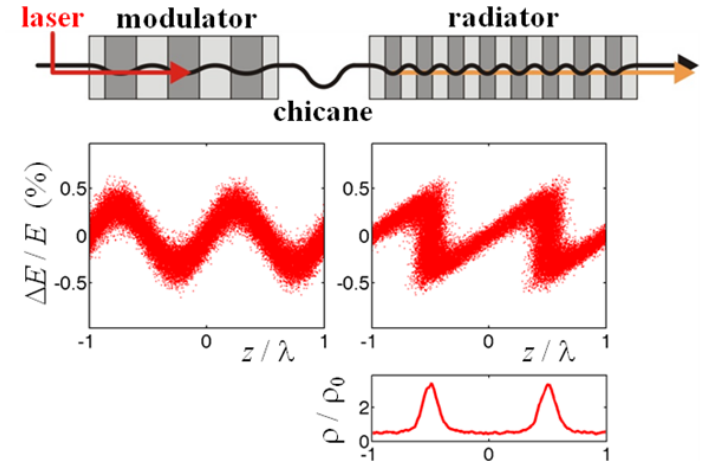
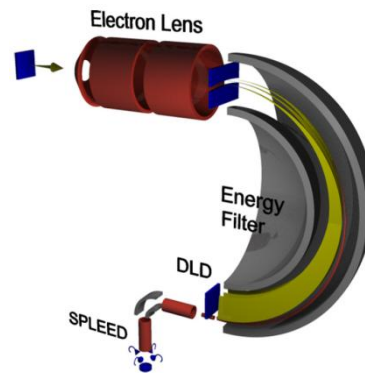

Facility for ultrashort VUV and THz pulses

Coherent harmonic generation (CHG)

- laser-induced energy modulation within a bunch "slice"
- density modulation in a magnetic chicane
- coherent radiation at harmonics of the laser wavelength (so far 80 nm, goal 53 nm)

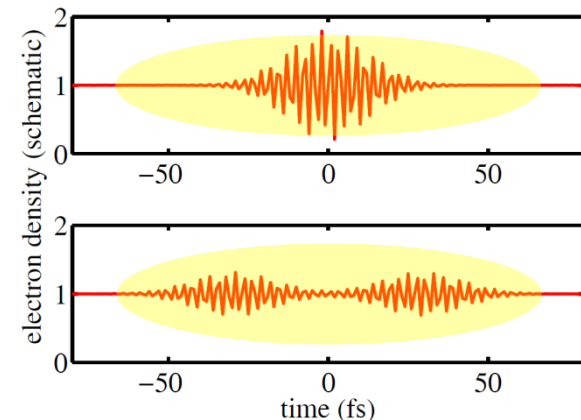
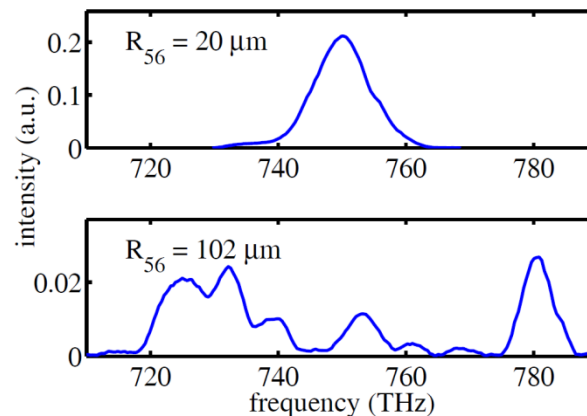
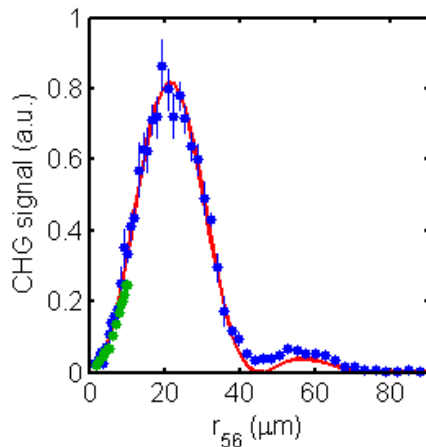
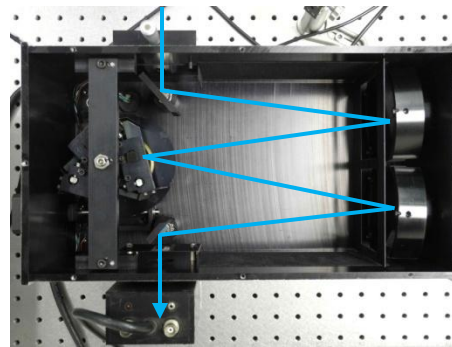
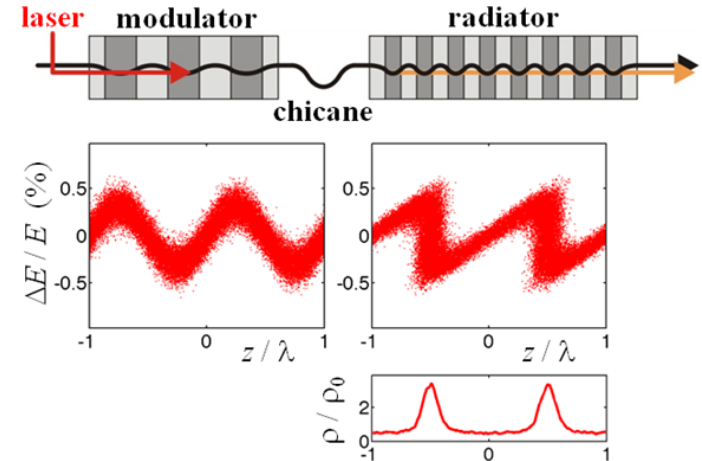

Facility for ultrashort VUV and THz pulses

Coherence of CHG radiation

- **Young's double-slit experiment**
- double-slit experiment with delay
- Michelson interferometer
- single-shot speckle measurements

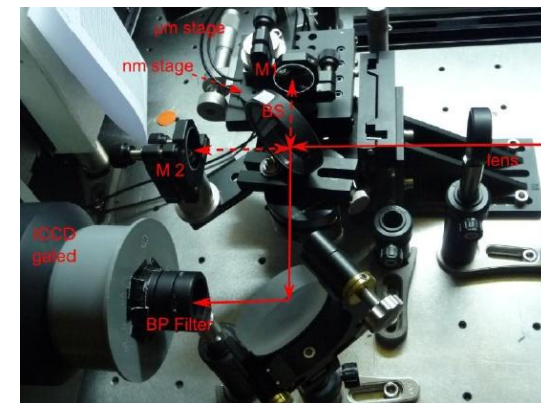
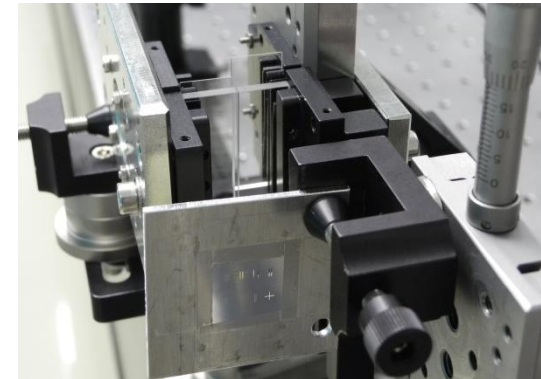
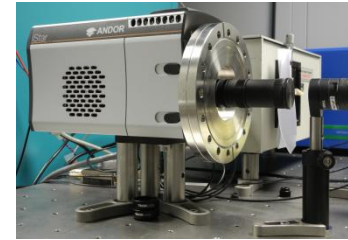
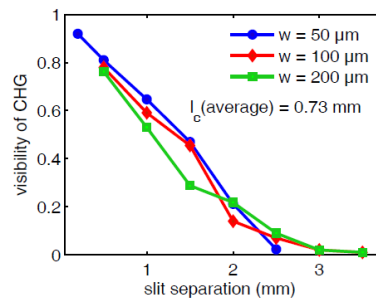
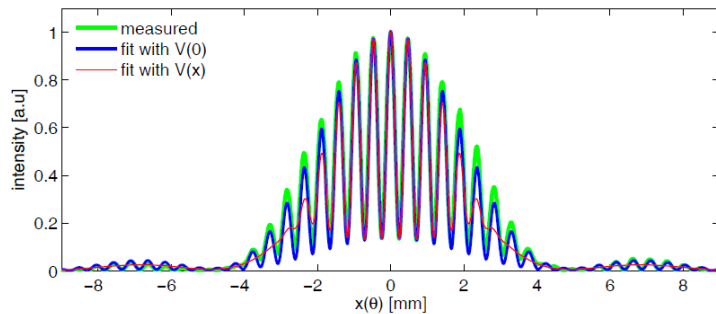
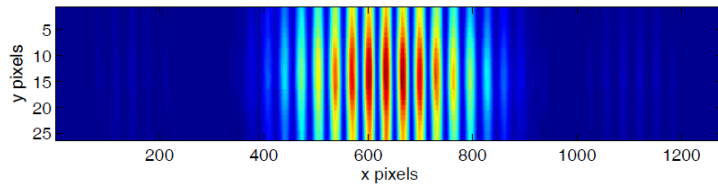

Facility for ultrashort VUV and THz pulses

Coherence of CHG radiation

- Young's double-slit experiment
- double-slit experiment with delay
- Michelson interferometer
- single-shot speckle measurements

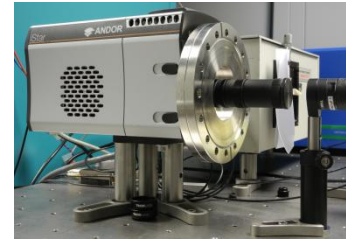

200 nm CHG spectral width 3 nm

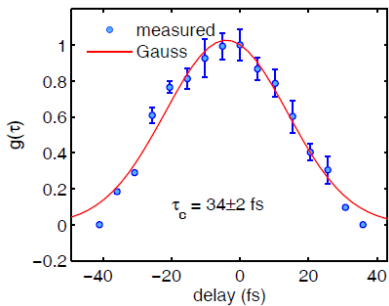

200 nm undulator with 10-nm filter

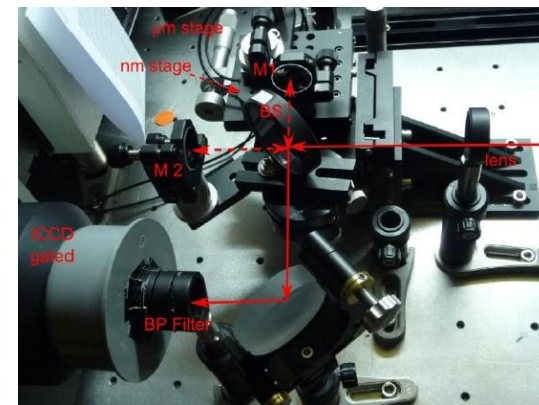
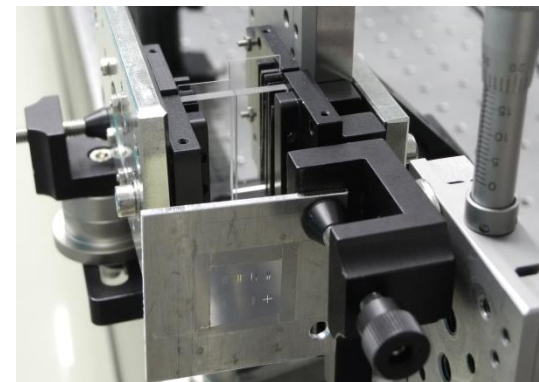
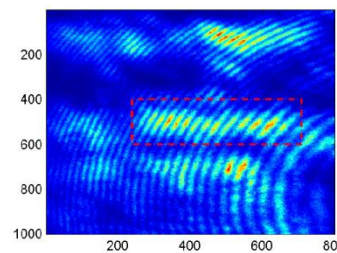
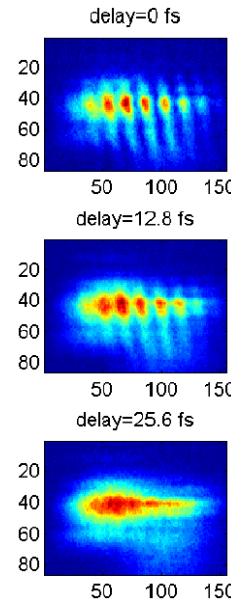
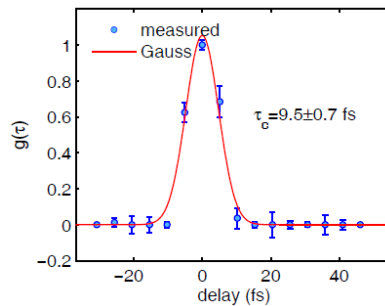

Facility for ultrashort VUV and THz pulses

Coherence of CHG radiation

- Young's double-slit experiment
- double-slit experiment with delay
- Michelson interferometer
- **single-shot speckle measurements**

200 nm CHG
spectral width 3 nm

200 nm undulator
with 10-nm filter

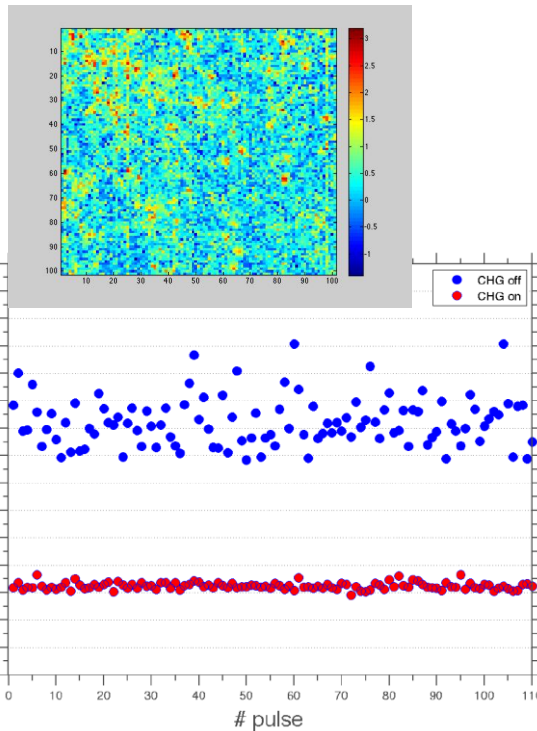
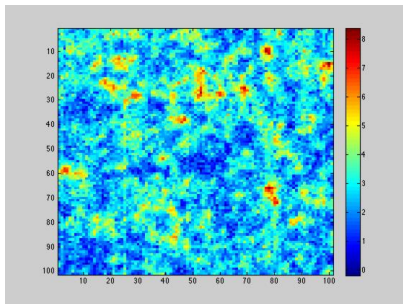

C. Gutt et al.,
Coherence Workshop,
Chicago (2014)
SNI Conference,
Bonn (2014)

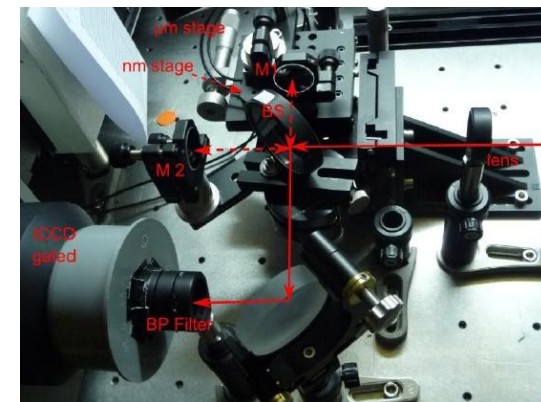
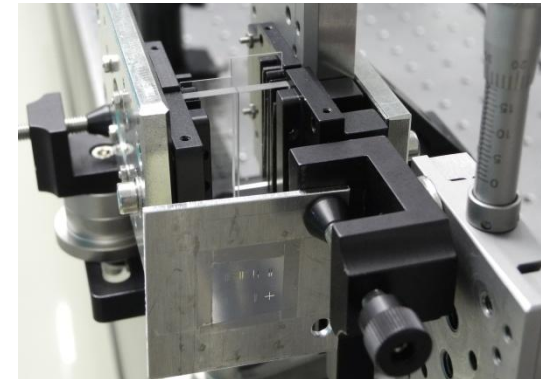
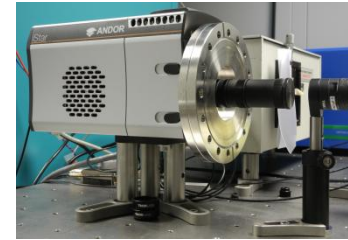

Facility for ultrashort VUV and THz pulses

RF-phase modulation

- suppresses coupled-bunch instabilities
- improves the beam lifetime

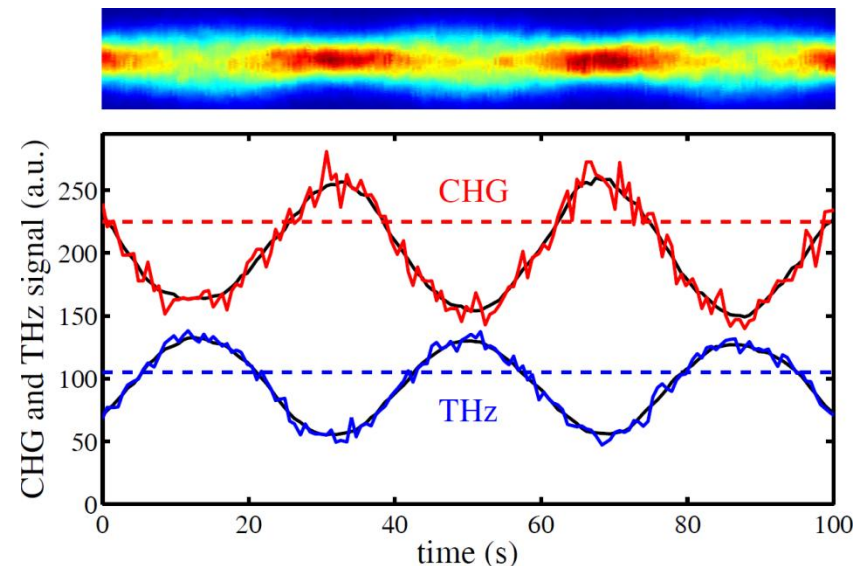
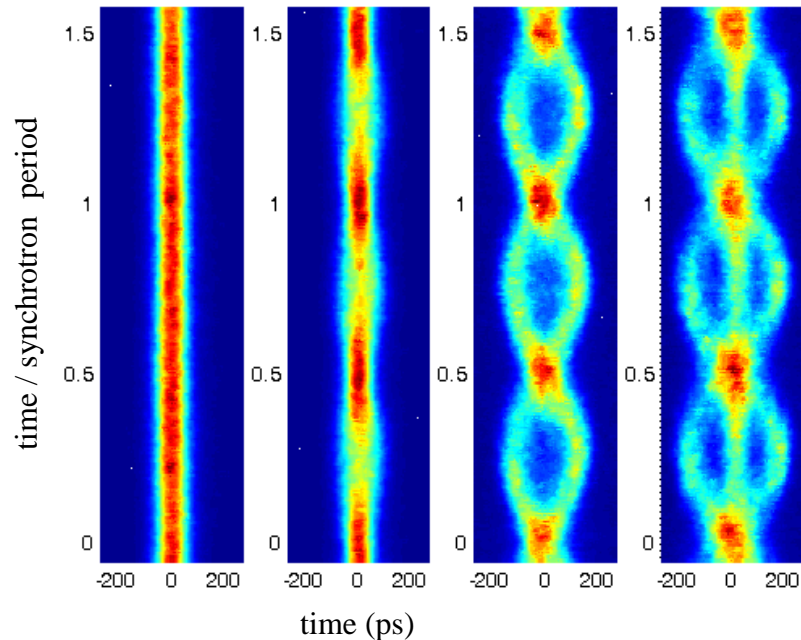

RF-phase modulation and CHG

- synchronize modulation with laser pulses
- phase scans (i) electronic delay
(ii) frequency mismatch (beating)
- CHG and THz signal out of phase*
- CHG and THz signal enhanced*

* depending on modulation amplitude and frequency, and on RF power (synchrotron frequency).

Facility for ultrashort VUV and THz pulses

Generation of broadband and narrowband THz radiation

- slow (InSb) and fast (YBCO) bolometers
- FT-IR spectrometer with Si bolometer
- coherent THz radiation observed over 19 turns
- **tunable narrowband spectra from 1 THz to 5.5 THz**

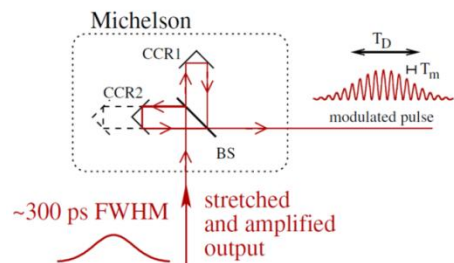

C. Evain et al., PRST-AB 13 (2010), 090703

YBCO detector
from IMS-KIT

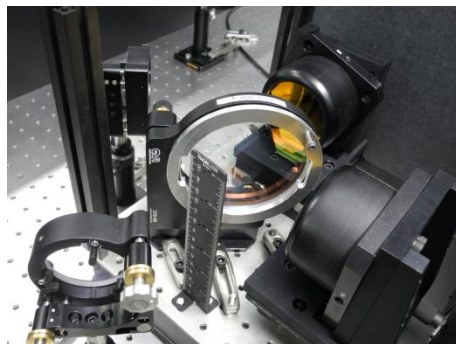

talk by Carsten Mai
tomorrow 09:55

collaboration with U... KIT Karlsruhe

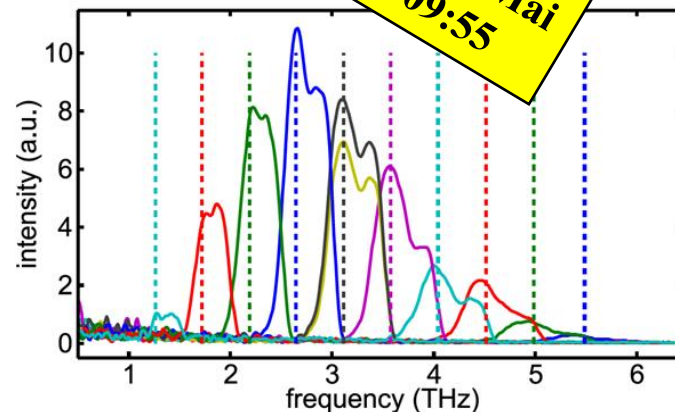

Echo-enabled harmonic generation at DELTA

Supported by Helmholtz ARD initiative (FZ Jülich)

- modulators: 2 short undulators
- radiator: present U250 undulator
- requires longer straight section
- modified storage ring optics
- additional undulator for "slicing"

G. Stupakov, Phys. Rev. Lett. 102, 074801 (2009).
 D. Xiang et al., Phys. Rev. Lett. 105, 114801 (2010).
 Z.T. Zhao et al., Nature Photonics 6, 360 (2012).

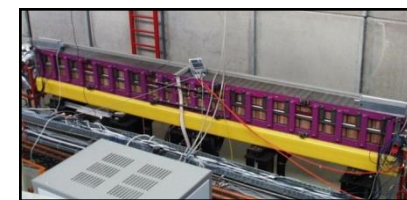
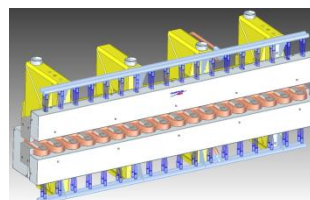
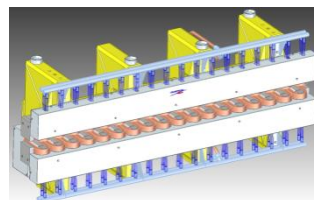
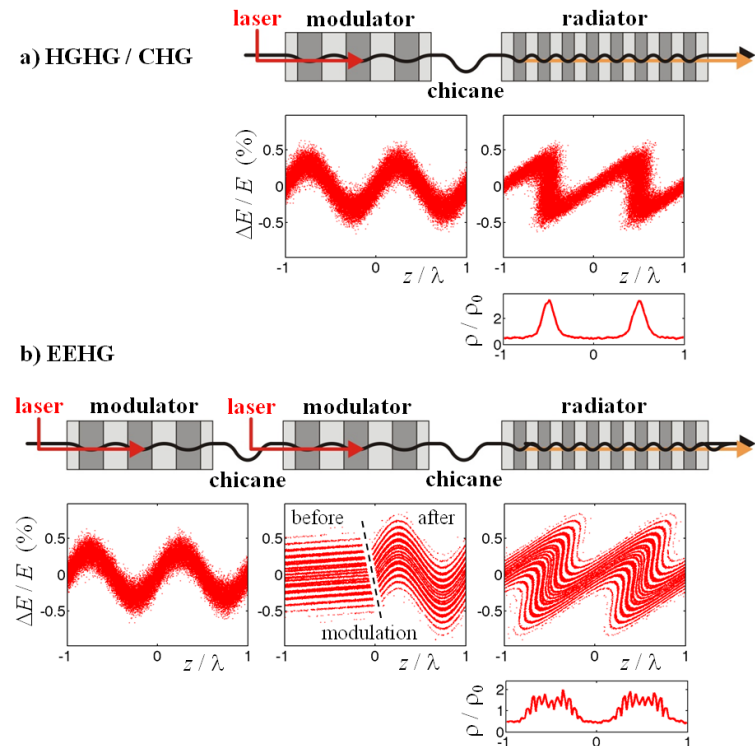
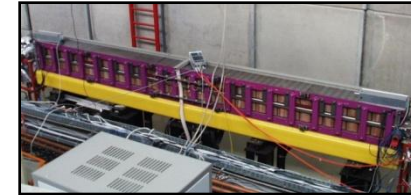

Echo-enabled harmonic generation at DELTA

Supported by Helmholtz ARD initiative (FZ Jülich)

- modulators: 2 short undulators
 - radiator: present U250 undulator
 - requires longer straight section
 - modified storage ring optics
 - additional undulator for "slicing"
- stogare ring lattice finalized
- two undulators ordered

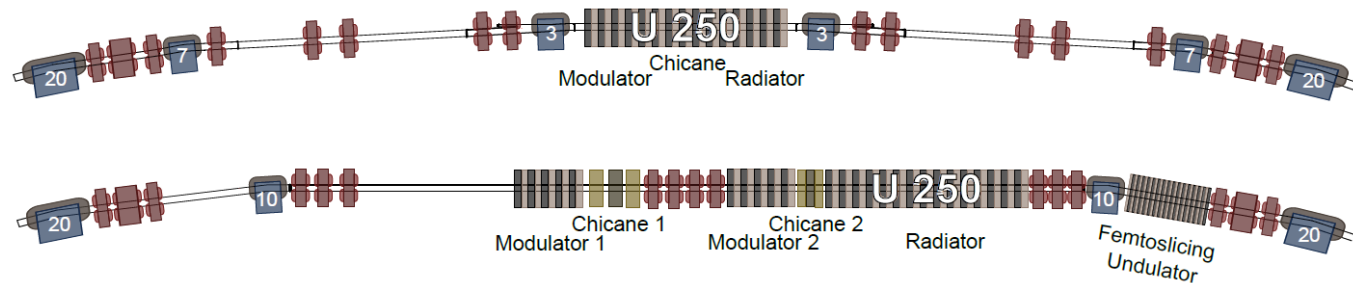

7+2 electromagnetic periods
 period length 200 mm
 gap 40 mm
 magnetic field 0.62 T

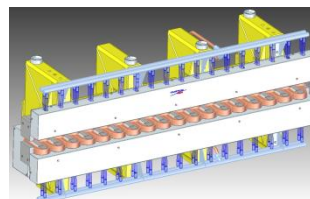
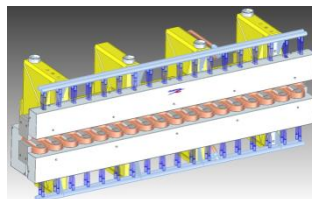

External activities

- DESY Hamburg:** FEL seeding (HGHG, EEHG)
- KIT Karlsruhe:** THz radiation, feedback
- HZB Berlin:** RF for BERLinPro and BESSY VSR

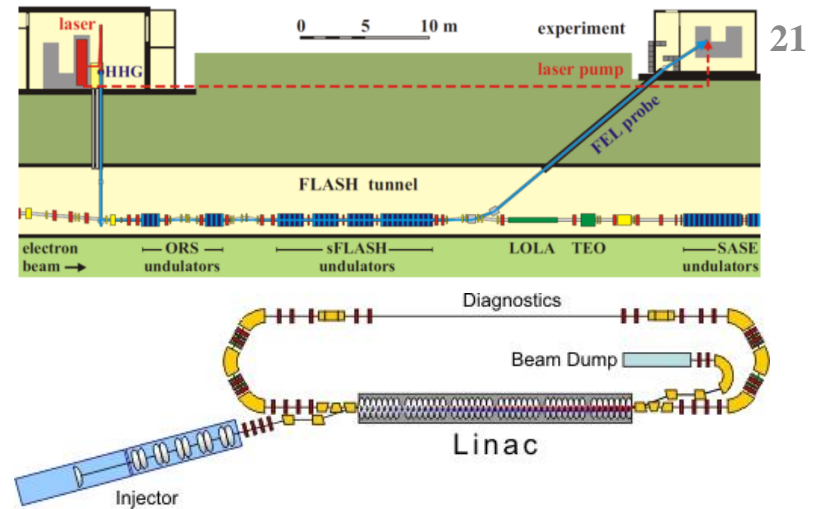
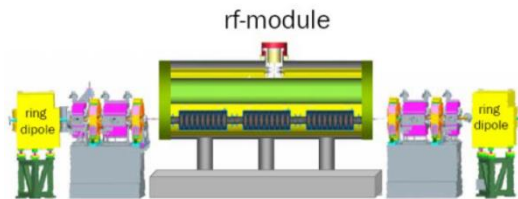

Accelerator physics in the bachelor and master curriculum

Bachelor, master, PhD theses
One-semester course on instruments of modern physics

- 2 hrs lecture
- 1 hr exercises

Two-semester accelerator course

- 2 hrs lecture
- 1 hr exercises
- 1 hr seminar
- 2 field trips
(Berlin, Hamburg, Mainz...)



Acknowledgements

- **Rektorat of TU Dortmund, Faculty of Physics, MEC, Kuratorium**
- **Users: FZ Jülich, ISAS e.V., Univ. Siegen and Bergische Univ. Wuppertal**
- **Tax payer: DFG, BMBF, MIWF NRW**
- **colleagues at DESY, FZJ, GSI, HZB, KIT and many others**
- **colleagues at DELTA: machine, beamlines, workshops, administration**